

Article number: 2030100M1050A2SK
 Description: E+G levelling foot
 GN 30-100-M10-50-A2-SK
 Note: SK With nut, External hexagon at the bottom

Measures

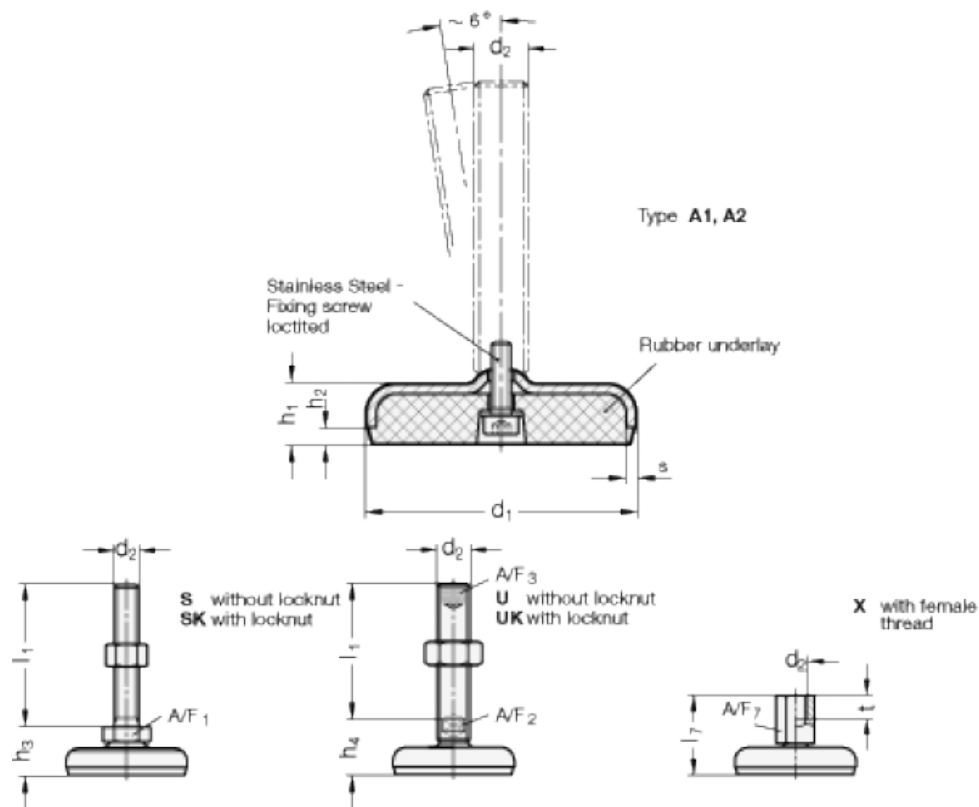

A/F1 = 17
 d_1 = 100
 d_2 = M10
 h_1 = 20
 h_2 = 6
 h_3 = 28
 l_1 = 50
 s = 3